

股票代號：6167



久正光電股份有限公司
2023年第二季法人說明會

10/12/2023



免責聲明

- 本簡報合併財務數字係根據國際財務報導準則編製，並經由會計師查核(核閱)簽證。
- 本公司並未發佈財務預測，本簡報所作有關本公司之說明，若涉及本公司對未來公司展望與產業發展上之見解，可能與未來實際結果存有差異，本公司並不主動更新。
- 本簡報內容非經由本公司書面許可，任何第三者不得任意取用或複製。



議程

主講人：經營團隊

公司介紹 Introduction

營業概況 Business Overview

產品發展及應用 Development & Application

未來營業發展 Future Business Development

HMI產品開發 HMI Product Development

財務資訊 Financial Information

Q&A



公司介紹 Introduction





公司簡介 Company introduction

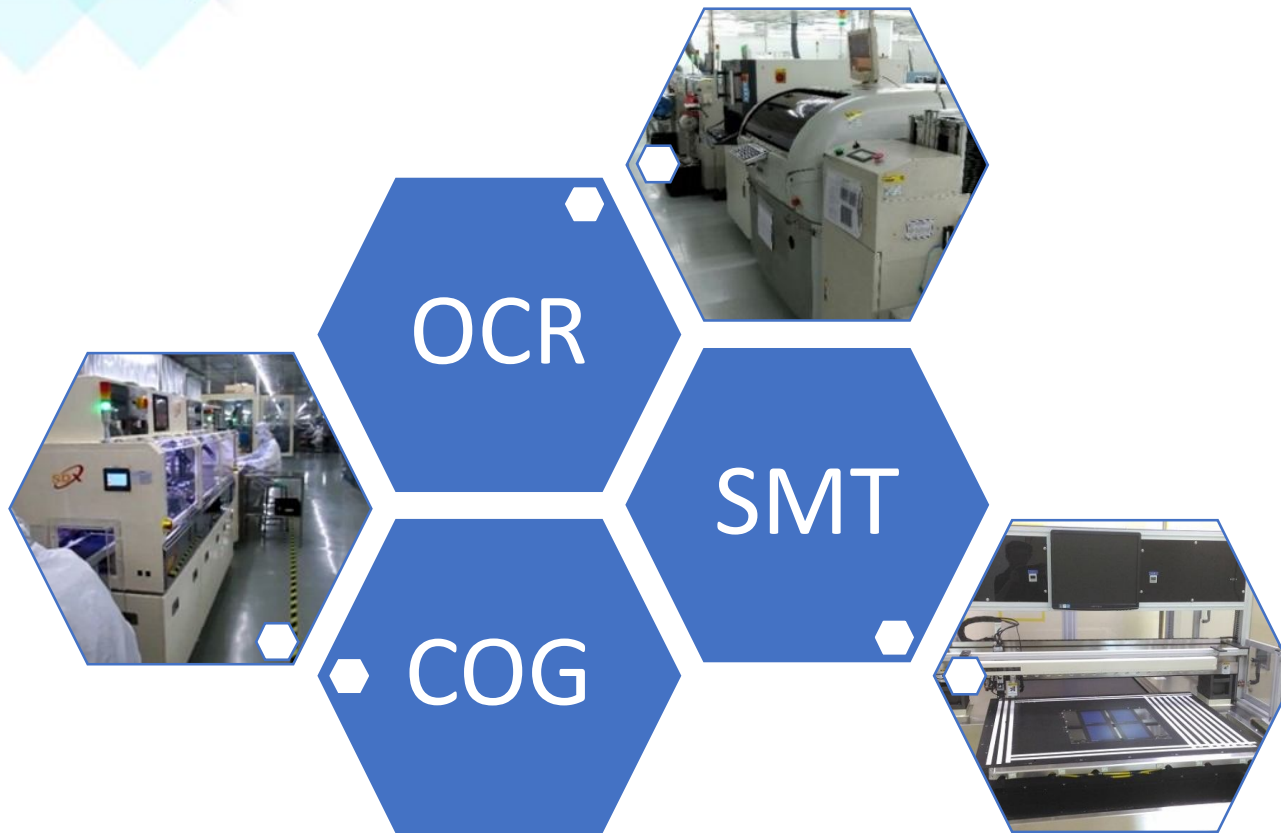

- ◆ 成立於 1991/09/02
- ◆ 上櫃時間 2002/03/26
- ◆ 生產基地: 台灣廠、江蘇廠
- ◆ 員工人數: 750 人
- ◆ 資本額: 新台幣 16.2 億元
- ◆ 主要業務: 液晶顯示器、觸控模組、嵌入式人機介面
產品之設計、製造及銷售



公司簡介 — 產品

Company introduction - Product



Mono Display

- TN/STN/FSTN
- VATN 1/64
- High contrast
- Low Power consumption



TFT Display

- 1.44"~23"
- Full viewing Angle
- Outdoor application
- Local Dimming

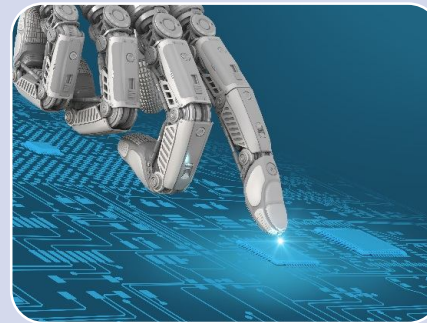

Touch Display

- Sensor only with High Sensitivity
- Water/ Glove resistance
- IK Ratings
- OCR



Embedded Display

- UART display
- GUI tool
- MCU / MPU
- SOM / Mini /Carrier board
- Mechanism



全球銷售通路 Global sales channel

超過 40 家長期合作代理據點，架構完整全球銷售通路，銷售產品。

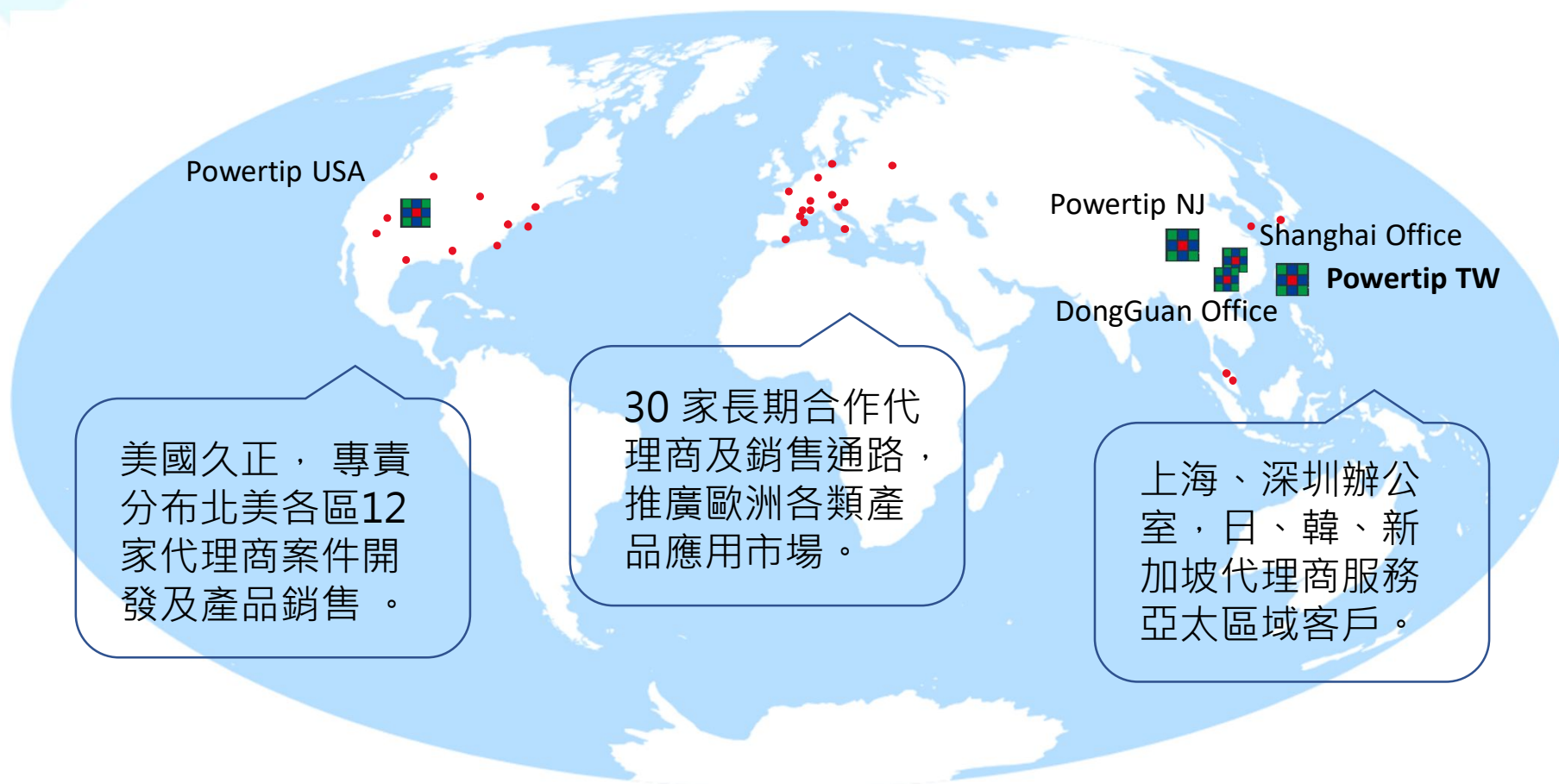



營業概況 Business Overview





營業現況 Business Status

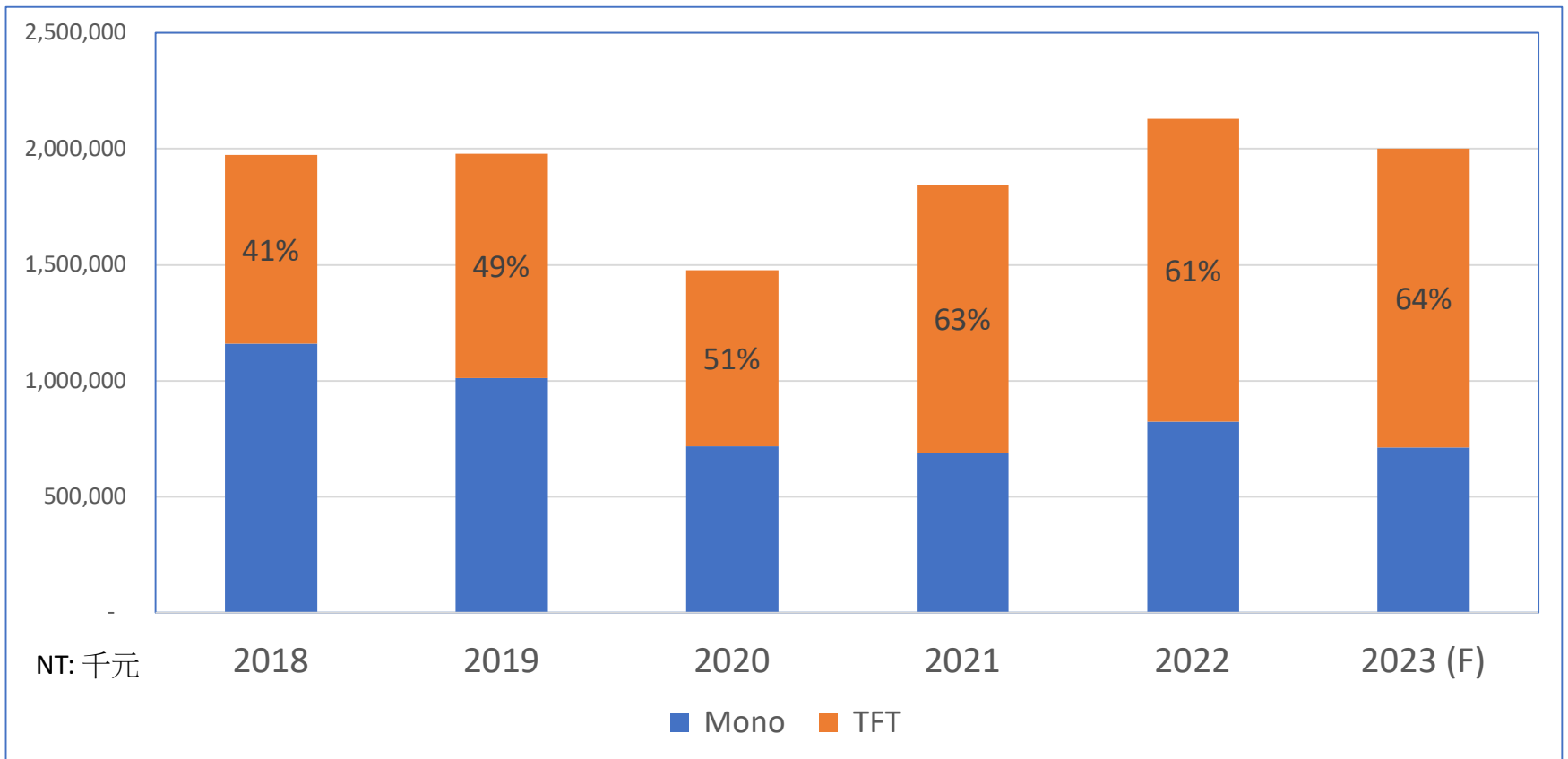

- TFT+觸控面板模組占比逐年提升，帶動平均單價及毛利上升。
- 暢通產品行銷管道架構，各國產業領域通路長期合作。



營業策略 Business Strategy

短期

- 穩定品質，庫存控管並兼具縮短交期滿足客戶需求。
- 持續工控、智能家居、安防、醫療、車載及戶外應用市場。

中期

- 強化現有通路，並擴展銷售據點。
- 垂直整合顯示器、觸控蓋板、主板之設計與生產。
- 提供一站式服務之產品整合設計與製造。

長期

- 提供客戶包含軟硬體設計及生產技術之解決方案。
- 嵌式顯示方案，觸控工業顯示螢幕開發設計及生產。
- 提供操作者與自動化設備溝通之完整人機介面解決方案。



產品發展及應用 Development & Application





產品發展方向 Product development

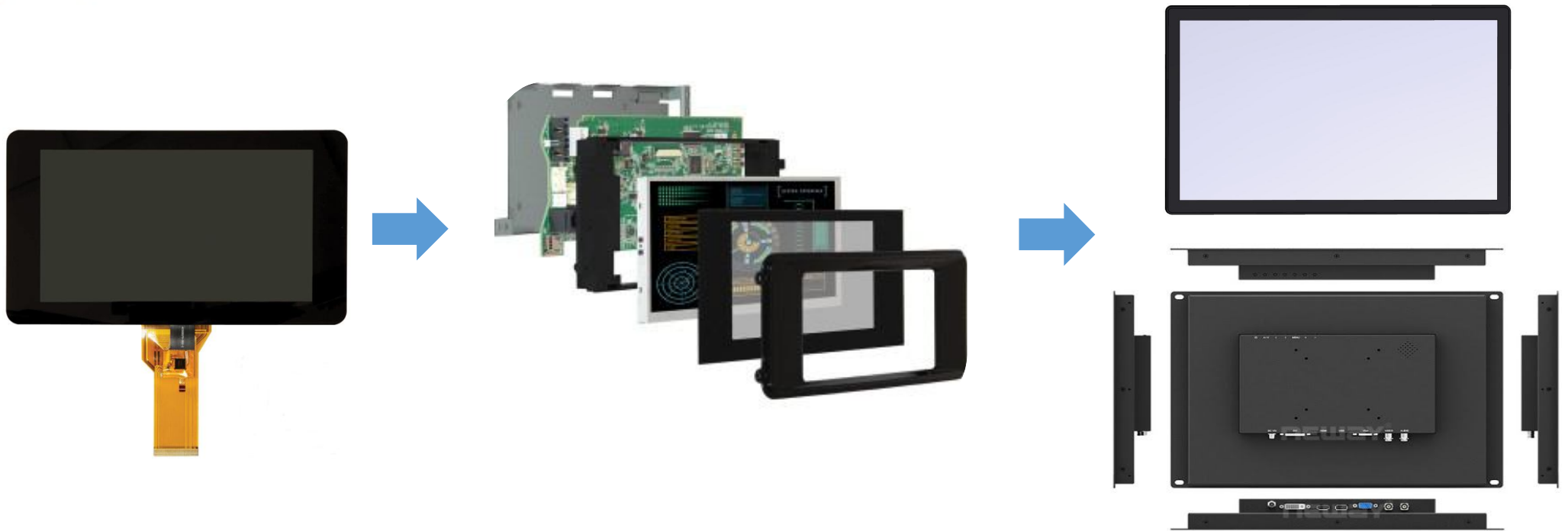

產品應用 Application



智能家居/通信/安防 39%

POS/醫療 12%



45% 工控/能源/儀表

4% 車載/其他



- 產品應用涵蓋多個領域，生命週期長，營收穩定。



未來營業發展 Future Business Development





營業成長動能 — 智能家居

Growth Momentum- Smart home

- 3.5" ~ 10.1" 顯示器
- 大尺寸電容式觸控模組
- 廣視角顯示器
- 耐高濕、高溫
- 抗干擾設計
- 機構設計
- 人機介面整合
- 觸覺反饋





營業成長動能 — 餐廳 POS

Growth Momentum- Restaurant POS

- 10.1" ~ 23" 顯示器
- 大尺寸電容式觸控模組
- 廣視角顯示器
- 耐高濕、高溫
- 抗干擾設計
- 機構設計整合
- 人機介面整合
- 觸覺反饋





營業成長動能 — 戶外應用

Growth Momentum- Outdoor

- 10" ~ 23" 顯示器
- 厚蓋板電容式觸控模組
- 光學膠貼合
- 耐高濕、高溫
- 抗 UV 紫外線
- 高亮戶外可視

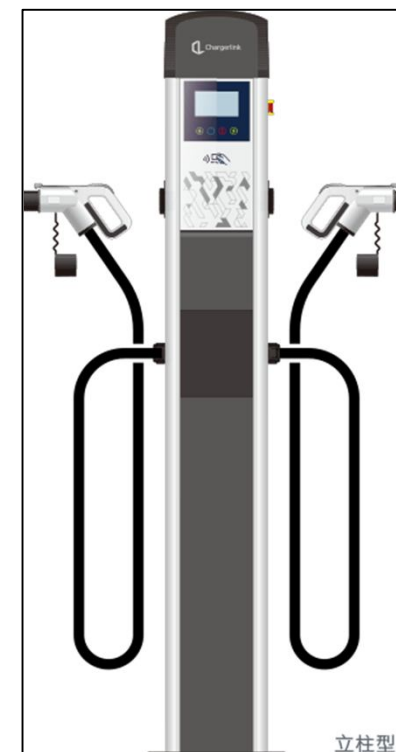

- 工控產品需求穩定，戶外應用因應規格需求，尺寸加大拉高出貨單價及毛利。



營業成長動能 — 電動車/充電樁

Growth Momentum- EV charger



- 受惠持續建設充電樁，相關顯示器營收隨之成長。



營業成長動能 — 熱泵

Growth Momentum- Heating Bump



- 3.5" ~ 10" 顯示器
- 大尺寸電容式觸控模組
- 廣視角顯示器
- 耐高濕、高溫
- 抗干擾設計

- 因應能源轉型與節能減碳，熱泵供熱系統需求持續增長。



營業成長動能 — 嵌入式人機介面

Growth Momentum- Embedded Solution

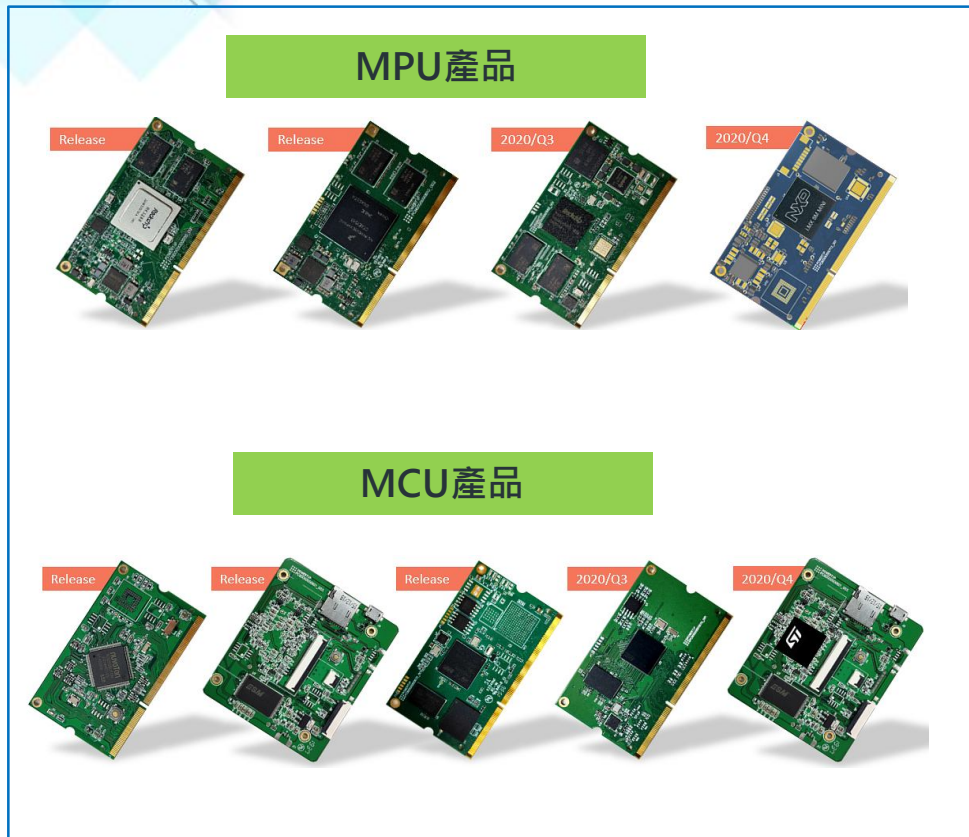

- 搭配人機介面軟硬體開發，提升為嵌入式解決方案供應商。



HMI產品開發 HMI Product Development



PTC HMI產品架構

- PTC HMI架構於4項專業技術領域

- PTC開發SBC搭配Display來建構完整之HMI產品,提供客戶嵌入式產品之Total Solution
- PTC SBC採用ARM 32/64 bit MPU內建Linux / Android OS提供客戶快速產品開發

1.SBC 單板電腦

ARM based MPU / MCU

3.Interaction 人機交互

Haptic Feedback



2.Display 顯示器模組

1.44" ~ 23.8" LCD Module

4.Mechanism 機構設計

Customized Design



HMI產品開發

SBC + Display



2. 產品/案件開發實績

- **PTC客製/標準品開發產品:**

PTC持續以客製化開發,協助客戶發展HMI產品

NXP / Rockchip / Renesas / Qualcomm / TI / ST...SBC + Display

軟硬體整合, Driver開發

多樣規格進行開發,協助客戶加速產品開發時程

- **PTC優勢:**

1. 針對硬體/軟體(OS BSP, Driver, UI Application) 能提供客戶Total Solution設計整合方向
2. 以SBC + Display開發HMI, Interface and Interaction為主投入技術開發
3. 具有靈活彈性搭配客戶端需求

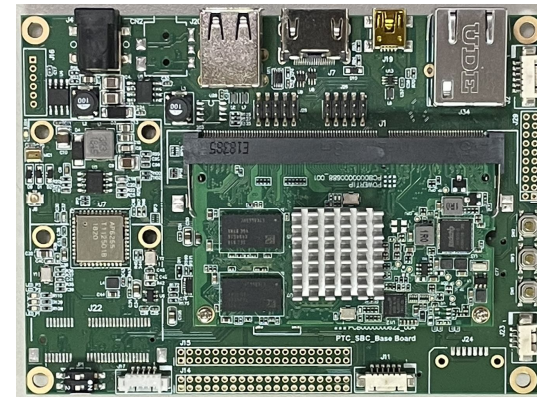

10.1" 跑步機

跑步機/腳踏車機

硬體: MCU客製板 (硬體完整設計)

軟體: 客製UI內容 & IO控制

顯示: 10.1" 1024x600

其它: 馬達控制, Sensor通訊整合, 特殊UI物件 & 畫面程式開發

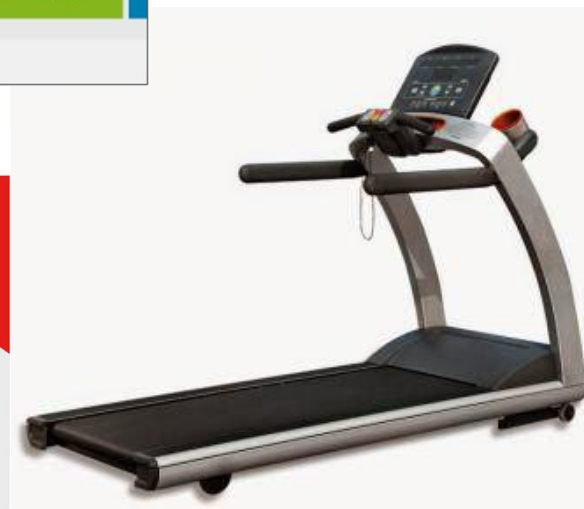
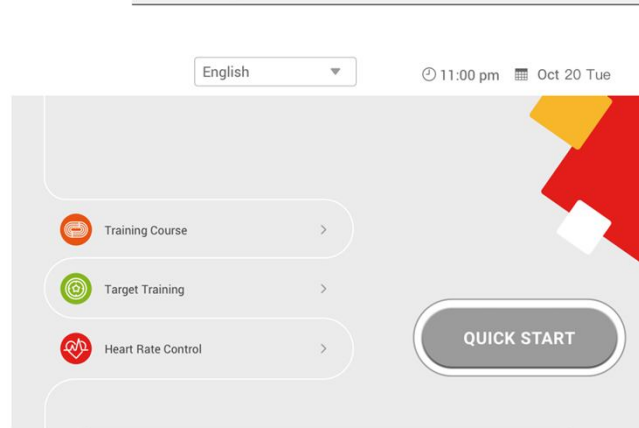
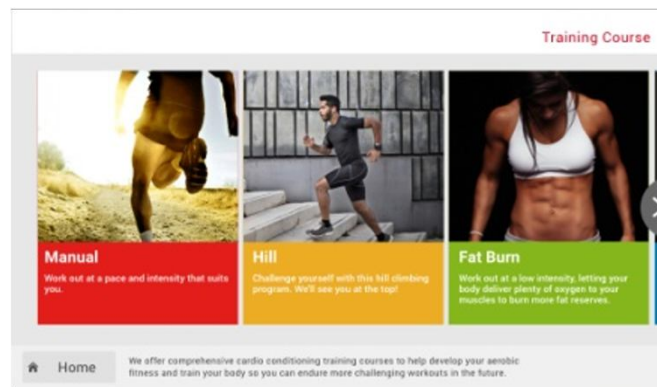

洗車機控制器

Car Wash

硬體: ST MCU客製板 (硬體完整設計)

軟體: Free RTOS & IO控制

其它: Sensor Driver

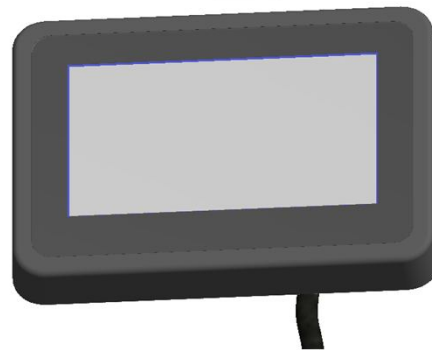

The best cash register
for your automatic car wash



13.3" /10.1" POS機

POS機

硬體: MPU SBC

軟體: Linux Ubuntu OS

顯示: 13.3" 1920x1080

10.1" 1024x600

其它: OS & Driver開發



Touch Less飲水系統控制器

7" 飲水系統

硬體: MPU SBC

軟體: Linux OS

顯示: 7" 800x480

其它: Driver / Power Control /
Sensor Control

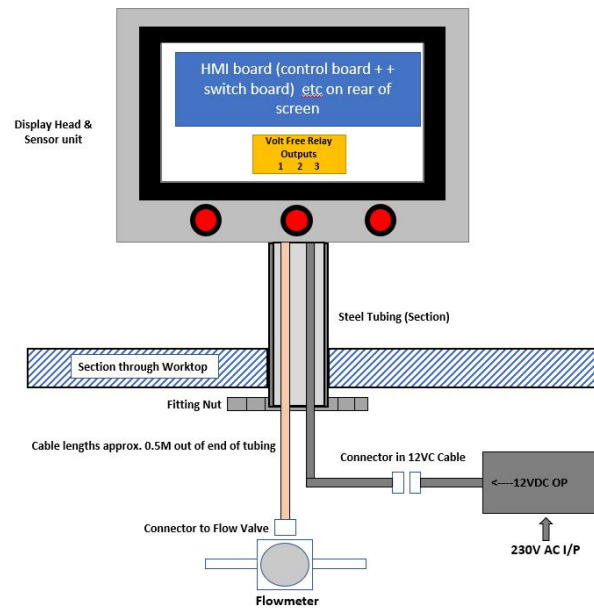

14" 醫療平板

醫療平板

硬體: 64bit MPU SBC + CTP Control

軟體: Android 11 OS

顯示: 14" 1920x1080, HDMI 4K

其它: USB TYPE-C充電, 鋰電池控制, Wifi驅動
程式, Camera程式, Audio控制

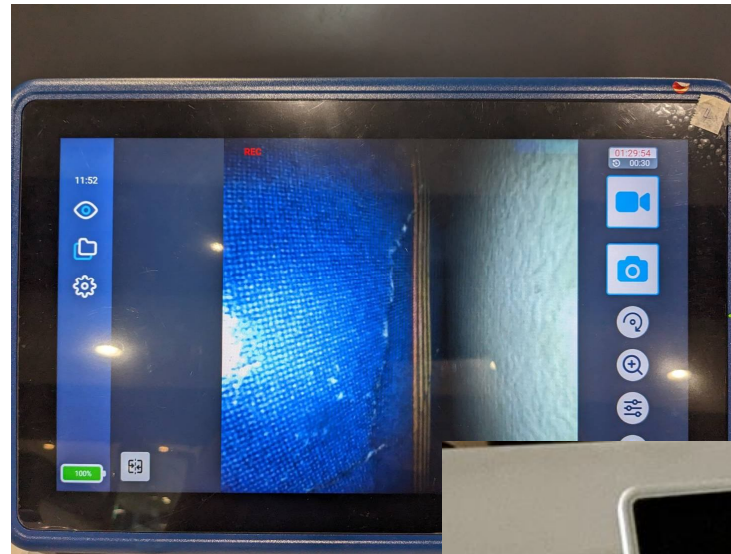

Touch Monitor

Touch Monitor

硬體: MCU+ CTP Control

軟體: Firmware

顯示: 15" 1024x768, 10.1" 1280x800

其它: USB Touch整合, CE/FCC Certification

應用: 咖啡豆篩選機, 金融設備



13.3" 醫療平板

醫療平板

硬體: 64bit MPU SBC + CTP Control
軟體: Android 13 OS
顯示: 13.3" 4K, HDMI 4K
其它: USB TYPE-C DP+PD, 鋰電池控制,
Wifi/BT驅動程式, Camera程式,
Hardware Driver



工業內視鏡系統

工業應用

硬體: MPU SBC

軟體: Linux OS

顯示: 8" 1280x800

其它: Sensor整合, Power / Video控制
, Function控制

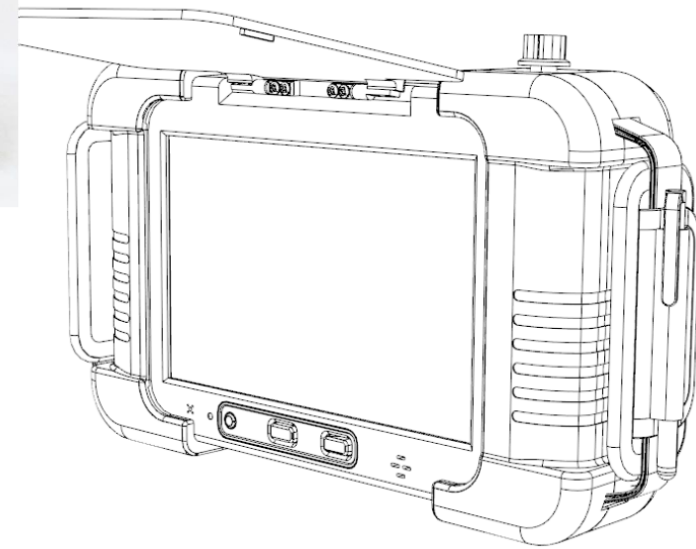

12.1" 工業控制器

工業控制

硬體: 32bit MCU
軟體: Free RTOS + Powertip GUI
顯示: 12.1" 800x600
其它: UI / Audio Control

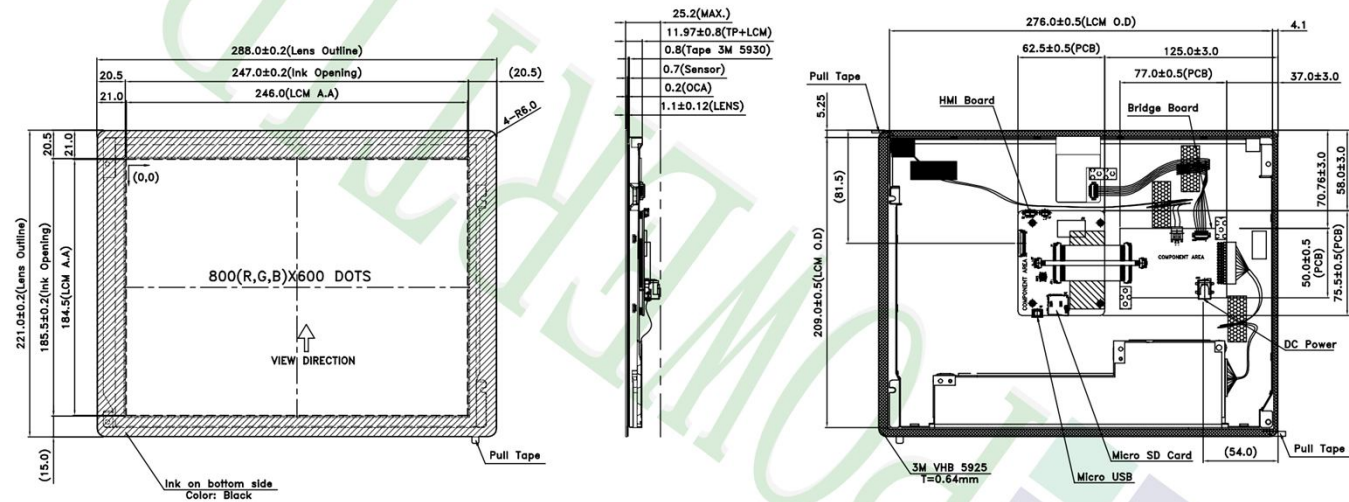

E-Scooter 電動摩托車控制面板

控制面板

硬體: 32bit MCU
軟體: Free RTOS
顯示: 3.5" 320x240
其它: Sensor/CAN Bus



Panel PC

Panel PC

硬體: 64bit MPU SBC + CTP Control
軟體: Android 11 OS
顯示: 10.1" 1280x800
其它: USB touch, Wifi/BT驅動程式,
Hardware Driver





人機交互技術開發

Haptic Feedback



Haptic Feedback

● 說明:

- 觸覺回饋技術應用層面廣泛,久正於產品增加此技術以提升互動性及價值性.
- 應用方面例如工控、車載、家用、醫療等,可增加對於人機互動/操作感受之回饋.



Haptic產品應用,例如:

- 車用端儀錶面板及虛擬按鍵
- 醫療產品,如盲人輔助
- 工業產品應用,如HMI
- AR擴增實境應用
- (真實環境與虛擬資訊整合)

Haptic Feedback

- **Haptic Feedback**

PTC 於2022年慕尼黑電子展~2023年Embedded World ~2023年SID展, 展出三款Haptic 裝置。採用不同 Haptic技術

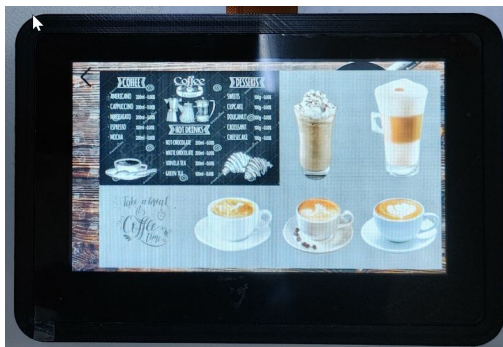

4.3" Coffee Machine

- Resolution : (RGB) 480*272
- System on : MCU
- Haptic : Force Feedback



10.1" Multi-Function Control

- Resolution : (RGB)1280*800
- System on : MPU
- Haptic : Surface Haptic

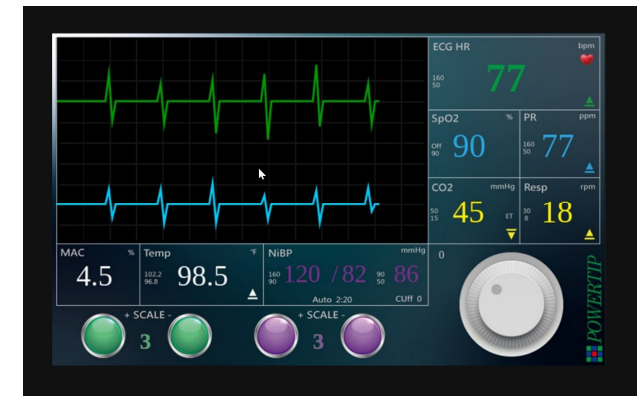

7" Medical Control

- Resolution : (RGB) 800*480
- System on : MPU
- Haptic : Force Feedback



財務資訊 Financial Information





合併損益表

Consolidated Statement of Comprehensive Income

單位：新台幣千元

項目	2023年H1		2022年		2021年	
	金額	%	金額	%	金額	%
營業收入	949,571	100	2,153,753	100	1,878,210	100
營業毛利	167,510	18	387,925	18	230,184	12
營業費用	112,889	12	220,830	10	191,888	10
營業淨利	54,621	6	167,095	8	38,296	2
稅前淨利	121,269	13	290,953	14	91,637	5
稅前EPS	0.75		1.79		0.57	
稅後淨利	106,901	11	249,034	12	80,894	4
稅後EPS	0.66		1.54		0.50	



合併資產負債表

Consolidated Balance Sheet

單位：新台幣千元

項目	2023年H1		2022年		2021年	
	金額	%	金額	%	金額	%
資產總計	2,383,087	100	2,347,604	100	2,131,795	100
現金及約當現金	819,812	34	773,869	33	443,005	21
應收帳款及票據	315,284	13	304,781	13	336,731	16
存貨	374,046	16	414,560	18	473,481	22
不動產、廠房及設備	537,839	23	557,543	24	584,866	27
其他資產	336,106	14	296,851	12	293,712	14
負債總計	618,614	26	556,933	24	577,392	27
流動負債	569,643	24	485,280	21	464,624	22
非流動負債	48,971	2	71,653	3	112,768	5
權益總計	1,764,473	74	1,790,671	76	1,554,403	73



Q&A



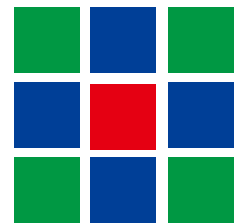

POWERTIP

Technology Corporation

THANK YOU!

<https://www.powertip.com.tw/>